

Data Sheet



Article number: 3901150020100

Description: Worm gear with solid input shaft
VF 150N-20-HS

Measures

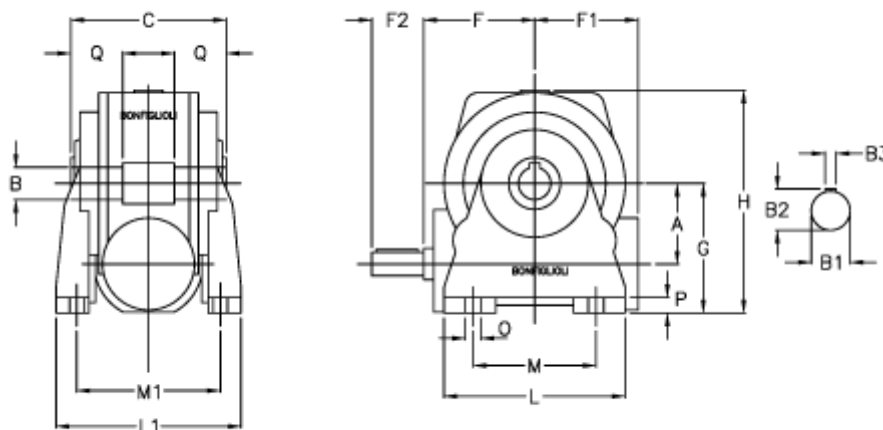

a	= 150.0	F1 = 179	O = 18.0
B	= 50	F2 = 65	P = 20
B1	= 35	g = 220	Q = 55.0
B2	= 38.0	H = 400.0	
B3	= 10	L = 330	
C	= 175	L1 = 260	
Description = VF 150N-xx-HS		m = 240	
F	= 185.0	M1 = 211.0	